

pressures near 1 Torr. In further experiments⁹⁰ we detected both modulated and unmodulated emission from excited species formed in the reactions of H(²P) with O₂, N₂, N₂O, NO, CO, CO₂, and SO₂ and have determined relative emission intensities for the different reactants.

From measurements of the intensity of scattered Lyman- α radiation in the presence of these same reactants⁹¹ a series of relative quenching cross sections was obtained. To convert from relative to absolute cross sections it was necessary to know the "trapping time," *i.e.*, the average time of imprisonment, of the Lyman- α photons in the atomic hydrogen gas. Trapping times were calculated using the theory of Holstein⁹² on the basis of atomic hydrogen pressures determined with an isothermal calorimeter probe. Holstein's theory has given good agreement with experiments on the trapping of resonance radiation of mercury⁹³ and potassium.⁹⁴ In the present case the quenching

(90) T. S. Wauchop and L. F. Phillips, *J. Chem. Phys.*, **51**, 1167 (1969).

(91) T. S. Wauchop, M. J. McEwan, and L. F. Phillips, *ibid.*, in press.

(92) (a) T. Holstein, *Phys. Rev.*, **72**, 1212 (1947); **83**, 1159 (1951); (b) P. J. Walsh, *ibid.*, **116**, 511 (1959).

(93) D. Alpert, A. C. McCoubrey, and T. Holstein, *ibid.*, **76**, 1257 (1949).

(94) G. Copley and L. Krause, *Can. J. Phys.*, **47**, 533 (1969).

cross sections obtained were about an order of magnitude smaller than would be expected, *e.g.*, by comparison with the recent results for potassium.⁹⁴ Current experiments in our laboratory, in which the trapping time for Lyman- α radiation is measured directly, suggest that the calculated times were too large, as a result either of our overestimating the atomic hydrogen pressure or of the early onset of pressure broadening.

Several conclusions can be drawn from a survey of upper atmosphere chemistry at this time. Perhaps the most obvious is that a remarkably fruitful interaction has occurred between laboratory and field workers. A second conclusion is that a considerable body of experimental and theoretical results has already been obtained, but, especially on the laboratory side, much more is to come. Finally, as investigations are extended to other planets, and possibly as our own atmosphere becomes more contaminated at high altitudes, an unexpectedly large variety of materials are likely to become eligible for study as a part of upper atmosphere chemistry.

We are grateful for support from the New Zealand Universities Research Committee and from the Directorate of Chemical Sciences of the U. S. Air Force Office of Scientific Research.

Photoelectron Spectroscopy

ARTHUR D. BAKER

Chemistry Department, University College of Swansea, Singleton Park, Swansea, United Kingdom

Received June 2, 1969

Photoelectron spectroscopy (PES) is a relatively new technique which permits the direct measurement of the energies required to remove valence shell electrons from atoms and molecules. It can also provide information on the bonding characteristics of orbitals, and in conjunction with other techniques can yield data concerning direct ionization, autoionization, and ion fragmentation processes. PES is thus of importance in fields such as molecular physics and theoretical chemistry, and it is also being developed as an analytical tool in a number of laboratories. Its potential for studying the orbitals involved in bonding adsorbed layers onto surfaces has also been demonstrated.¹

Technique

Ionizing photons (frequency ν in the vacuum ultraviolet) are directed onto a sample, generally in the gas phase. Electrons may then be ejected from orbitals within the sample molecules. The energy, E , that an

ejected electron possesses depends upon the difference in the energy imparted to the irradiated molecule by the photon, *i.e.*, $h\nu$, and the energy required to eject the electron (*i.e.*, the ionization potential, I , characterizing the orbital which the electron occupied in the molecule). This is the Einstein photoelectric law and is summarized in eq 1.

$$E = h\nu - I \quad (1)$$

In a photoelectron spectrometer, electrons ejected in this way are separated according to their kinetic energies, and are recorded. A photoelectron spectrum simply shows the relative numbers of electrons collected over the kinetic energy range from 0 up to $(h\nu - I_1)$ where I_1 is the lowest ionization potential of the compound being examined. Different bands in the spectrum thus relate to the ionization of electrons from different orbitals in the irradiated substance.

The expulsion of an electron from a molecule involves the simultaneous formation of an ion which may be in its ground or an excited electronic state,

(1) W. T. Bordass and J. W. Linnett, *Nature*, **222**, 660 (1969).

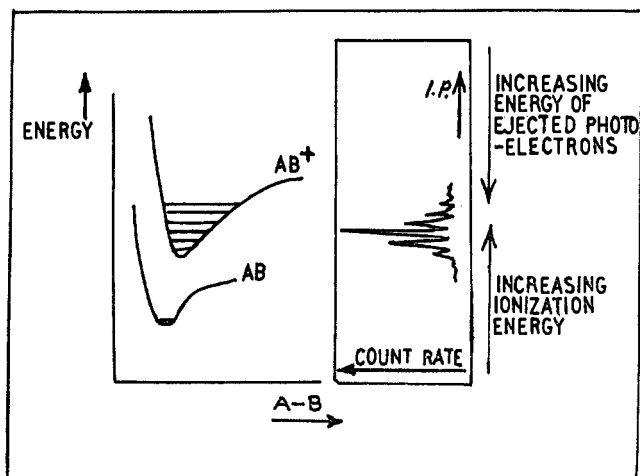

Figure 1. Production of ions in excited vibrational levels causing the presence of fine structure in PE spectral bands.

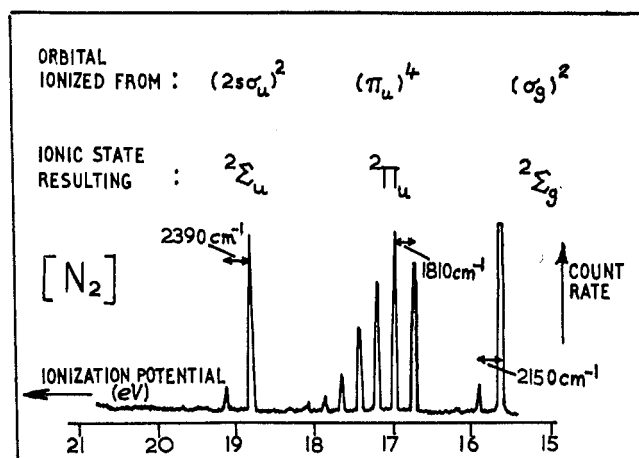

Figure 2. The photoelectron spectrum of N_2 excited by irradiation with photons of wavelength 584 \AA . The spectrum shows bands corresponding to the ejection of electrons from the $(2p\sigma_g)$, $(2p\pi_u)$, and $(2s\sigma_u)$ orbitals. The x axis is calibrated in terms of orbital ionization potential, computed from $(h\nu - E)$ (see text) where $h\nu = 21.21 \text{ eV}$ in this case.

depending upon the orbital from which the electron came. The formation of ions in nonzero vibrational levels (known as nonadiabatic ionizing processes) results in the presence of fine structure on bands (Figure 1) since in such cases some of the photon energy goes into the vibrational excitation of the ion and thus less kinetic energy can be imparted to the leaving electron. For example, the second band in the PE spectrum of N_2 (Figure 2) shows the formation of N_2^+ ions ($2\Pi_u$ electronic state) in vibrational levels up to at least $v = 7$. The vibrational frequencies in the three ionic states of N_2 detected by PES are 2150, 1810, and 2390 cm^{-1} . As the vibrational frequency in the molecular ground state is 2345 cm^{-1} , ionizations from, respectively, weakly bonding, strongly bonding, and weakly antibonding orbitals are implied. This agrees with the theoretically deduced bonding natures of the three highest occupied levels of the nitrogen molecule and illustrates the applicability of PES in assessing the forms of molecular orbitals.

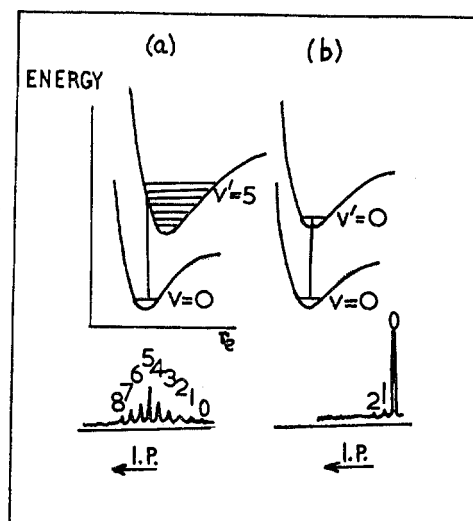

Figure 3. Effects on ionic potential energy curves (top) and on PE spectra (bottom) of ionizing electrons from (a) strongly bonding and (b) weakly bonding orbitals.

The number of ionic vibrational levels populated is also characteristic of the bonding type of orbital which the ejected electron originally occupied. Ionization from a bonding orbital implies that the equilibrium internuclear coordinates of the ion will be appreciably different from those of the molecule (Figure 3a). According to the Franck-Condon principle the vibrational level of the ionic state most likely to be populated is one which allows the internuclear coordinates to approximate to those of the molecule. In the example shown in Figure 3a this corresponds to the production of an ion in the $v' = 5$ state. Other vibrational levels of the ion are populated by the ionizing act, but with lower probabilities governed by the Franck-Condon overlap. Ionization of a nonbonding or very weakly bonding or antibonding electron generally has little effect on the equilibrium internuclear parameters (Figure 3b), and the maximum overlap of vibrational wave functions then favors an adiabatic transition, *i.e.*, one from and to states with $v = 0$. In such cases the transition probabilities relating to the population of higher vibrational levels are small. Thus the first and third bands in the spectrum of N_2 clearly relate to the ejection of electrons from virtually nonbonding molecular orbitals.

From the simple example of the nitrogen spectrum it can thus be seen that PES furnishes data on the energies, internuclear distances, vibrational frequencies, and general properties of the eigenstates of the molecular ion. From this one can infer in a molecular orbital model the energies of the molecular orbitals from which the electrons are ejected and say whether these orbitals are bonding, nonbonding, or antibonding.

Figure 4 shows one example of the appearance of a PE spectral band when two vibrational modes are excited simultaneously in an ion. The excitation of several modes can cause highly complex fine structure on bands or lead to a situation in which individual vibrational peaks are unresolved so that a broad band

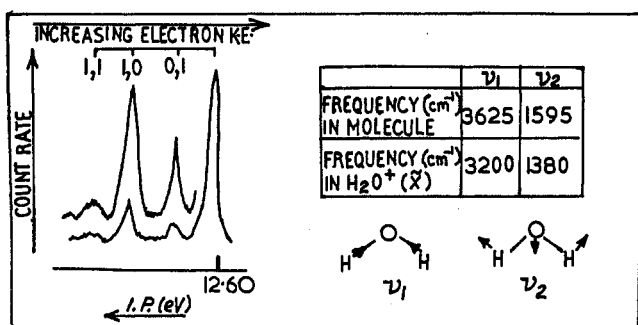

Figure 4. One example of the form of a PE spectral band when two modes of vibration are simultaneously excited by an ionization process.

is obtained. Lack of fine structure in a broad band can also imply that the ion formed is short-lived (because of either dissociation or predissociation, *e.g.*, see ref 2) with the result that vibrational peaks are broadened to such an extent that individual levels are again indistinguishable.

In the remainder of this Account the results and applications of photoelectron spectroscopic measurements on a number of compounds will be discussed, but first the development of the experimental technique is considered.

Instrumentation

A. The Ionizing Source. Potential ionizing sources for electron spectroscopic studies include electrons, photons, X-rays, and metastable atoms. Electrons have as yet been largely untried (but see ref 9, p 177) because of the practical difficulties in generating a sufficiently intense monochromatic supply (electrons emitted from a filament have a quasi-Maxwellian distribution of velocities) and because of the relatively complex nature of the electron impact ionization process (eq 2). Two electrons leave the collision site, and the

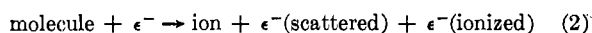

excess energy above the ionization potential is partitioned between them. Thus it is really necessary to examine both these electrons to obtain meaningful information.

Photons are the most widely used ionizing source. This is because of the simple nature of the ionization process, all the excess photon energy appearing as kinetic energy in just one ejected electron. Resonance radiation from a helium discharge tube provides what is in many ways the ideal source of photons for PES. Virtually all the ionizing radiation released has a wavelength of 584 Å, corresponding to an energy of 21.216 eV/photon, and this is sufficient to eject an electron from the valence shell orbitals of all substances except helium itself and neon. Radiation emitted from other noble gas (especially argon and neon) discharge lamps has been used, but such lamps suffer from the disadvantage that they produce doublet emission lines

(2) H. J. Lempka, T. R. Passmore, and W. C. Price, *Proc. Roy. Soc. (London)*, **A304**, 53 (1968).

Table I
Emission Lines of Hydrogen and the Rare Gases
Suitable for Use in PES

| Gas | Wavelength, Å |
|----------------|------------------------|
| He | 584 |
| | 304 (He ⁺) |
| H ₂ | 1215 (Lyman-α) |
| Ar | 1048, 1067 |
| Ne | 736, 744 |
| Kr | 1165, 1236 |
| Xe | 1296, 1470 |

(Table I) which are in addition lower in energy than the corresponding helium line. Photons with energies greater than 21.2 eV can be produced by modifying the conditions under which the discharge takes place in one of the conventional noble gas lamps. Radiation characteristic of the noble gas ions (*e.g.*, He⁺) is then released (see Table I), but it has not yet proved possible to excite the noble gas ion resonance lines without at the same time producing the corresponding atomic resonance lines at a much greater intensity. A vacuum monochromator used in conjunction with a light source emitting a many-lined radiation or continuum can provide a variable energy photon source for PES, but the intensity obtainable is only a small fraction of that available from a resonance lamp. The resultant signal-to-noise problems have restricted photoelectron studies with monochromators to a handful of atoms and molecules.³⁻⁸ The energy of X-rays has also been put to use as an exciting source for PES.⁹ Here the energy is sufficient to eject an electron from very deep orbitals (*e.g.*, C 1s) in the K shells of atoms and molecules, but the inherent width of the X-ray lines (0.8 eV) precludes any high-resolution studies. PES with X-rays is also known as ESCA (electron spectroscopy for chemical analysis) and, as the name implies, has possible application in analysis. A commercial ESCA machine is at present under construction by Varian.

The use of metastable atoms (especially He 2¹S and 2³S metastables) as ionizing particles for electron spectroscopy has been investigated by Cermak and his associates.^{10,11} The results to some extent duplicate those obtained with photon sources (although no fine structure is detected) but can in addition shed light on short-lived complexes incorporating the bombarding atom and the target molecule and can also reveal any basic differences in the selection rules for the different types of ionization processes.

B. Electron Energy Analyzers. The electrons

(3) F. J. Vilesov, B. L. Kurbatov, and A. N. Terenin, *Soviet Phys. Dokl.*, **6**, 490 (1961); **6**, 883 (1962).

(4) R. I. Schoen, *J. Chem. Phys.*, **40**, 1830 (1964).

(5) F. J. Comes and H. J. Salzer, *Z. Naturforsch.*, **19a**, 1230 (1964).

(6) J. A. R. Samson and R. B. Cairns, *J. Opt. Soc. Amer.*, **56**, 552 (1966).

(7) A. J. Blake and J. H. Carver, *J. Chem. Phys.*, **47**, 1038 (1967).

(8) J. A. R. Samson and R. B. Cairns, *Phys. Rev.*, **173**, 80 (1968).

(9) K. Siegbahn, *et al.*, "ESCA—Electron Spectroscopy for Chemical Analysis," Uppsala University, Uppsala, Sweden, 1967.

(10) V. Cermak, *J. Chem. Phys.*, **44**, 3781 (1966).

(11) V. Cermak, *Collection Czech. Chem. Commun.*, **30**, 169 (1965); **33**, 2739 (1968); V. Cermak and Z. Herman, *Chem. Phys. Letters*, **2**, 359 (1968).

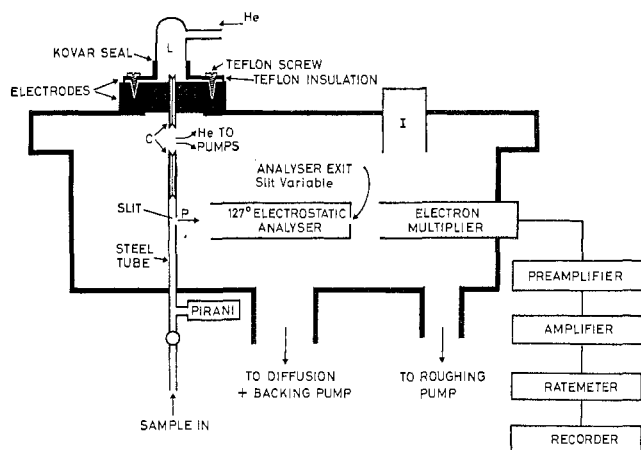

Figure 5. Schematic representation of a photoelectron spectrometer. The analyzer plates voltage sweep is driven by the recorder; L, light source; I, ionization gauge; C, aligned capillary tubes; P, photoelectrons.

ejected from orbitals by impacting photons have been sorted out into different energy bands by the use of electrostatic^{12,13} and magnetic¹⁴ deflection analyzers and by the use of retarding cylindrical,^{2,15-18} spherical,¹⁹ and parallel-plate grids.²⁰ The different types of analyzer are schematically illustrated in a previous review by Turner,²¹ the originator of the technique. The commercially available Perkin-Elmer He 584-Å photoelectron spectrometer (see Figure 5) utilizes a cylindrical electrostatic analyzer with plate radii of 4.5 and 5.5 cm. Detection of the electron flux emerging from the analyzer is with an electron multiplier coupled to an amplifier and rate meter. The photoelectron spectrum as recorded shows the number of electrons reaching the detector (y axis) as a function of analyzer voltage (x axis).

C. Calibration of Spectra. The algebraic relationship between the analyzer voltage and the kinetic energy of collected electrons is readily obtained by using a "standard" substance whose ionization potentials are available from independent sources. One or more of the noble gases argon, krypton, or xenon can, for example, be used for calibration, and this enables one to provide photoelectron spectra with an orbital ionization potential scale reading directly. A spectrum obtained with a focusing analyzer is equivalent to the first differential of one obtained with retarding grids.²²

(12) D. W. Turner, *Proc. Roy. Soc. (London)*, **A307**, 15 (1968).

(13) J. H. D. Eland and C. J. Danby, *J. Sci. Instr.*, **1**, 406 (1968).

(14) D. W. Turner and D. P. May, *J. Chem. Phys.*, **45**, 471 (1966).

(15) M. I. Al-Joboury and D. W. Turner, *ibid.*, **37**, 3007 (1962).

(16) M. I. Al-Joboury and D. W. Turner, *J. Chem. Soc.*, 5141 (1963).

(17) M. I. Al-Joboury, D. P. May, and D. W. Turner, *ibid.*, 6350 (1965).

(18) M. I. Al-Joboury and D. W. Turner, *ibid.*, 373 (1967). Other examples of retarding grid analyzers can be found in ref 3-8. Also see P. H. Doolittle and R. I. Schoen, *Phys. Rev. Letters*, **14**, 348 (1965).

(19) D. C. Frost, C. A. McDowell, and D. A. Vroom, *Proc. Roy. Soc. (London)*, **A296**, 566 (1967); *J. Chem. Phys.*, **46**, 4255 (1967).

(20) R. Spohr and E. von Puttkamer, *Z. Naturforsch.*, **22a**, 705 (1967).

(21) D. W. Turner, *Advan. Mass Spectrom.*, **4**, 755 (1968).

(22) D. W. Turner, *Chem. Brit.*, **4**, 435 (1968).

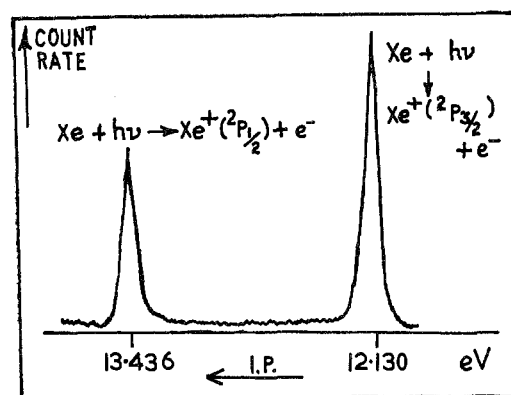

Figure 6. The He 584-Å PE spectrum of xenon, obtained using a scale expansion mode.

Most grid spectra appearing in the literature are in fact differential spectra, but those of Frost and his colleagues are not, showing "steps" rather than peaks. In this review we shall confine ourselves largely to the band type of spectrum.

Photoelectron Spectra of Atoms and Molecules

The photoelectron spectra of atoms are simple, showing a number of sharp peaks¹⁴ (or steps in undifferentiated grid spectra¹⁹) corresponding to the number of orbitals accessible to ionization with the particular ionizing source used, provided that spin-orbit couplings in the resulting ions are considered. Thus the He 584-Å spectrum of xenon shows two peaks separated by 1.3 eV even though ionization from only one MO is possible (Figure 6). The relative heights of the peaks in the spectra of the noble gases have been rationalized in terms of the relative probabilities of populating the $^2P_{1/2}$ and $^2P_{3/2}$ ionic states at various incident photon wavelengths.^{8,14} The width of a noble gas PE spectral peak at half its maximum height is frequently quoted as the "resolving power" of the instrument producing the spectrum. The best resolving power achieved to date is a little over 10 mV (using a spherical electrostatic analyzer), but considerably worse resolution coupled with asymmetric peak shape are features of spectra produced by the early cylindrical grid type of instrument.^{19,23}

The PE spectra of several gaseous homonuclear and heteronuclear diatomic molecules have been extensively studied.^{2,12,14} May and Turner¹⁴ were the first to detect well-resolved vibrational structure in the PE spectral bands of such compounds and to relate the positions and appearances of the bands to the electronic structures of the compounds. However their original interpretations of the NO PE spectrum have been criticized by Huber²⁴ and also by Collin and Natalis.²⁵ Higher resolution studies²⁶ have shown Huber's analysis of the spectrum to be correct (Figure

(23) D. W. Turner, *Phys. Methods Advan. Inorg. Chem.*, **74** (1968).

(24) K. P. Huber, *Can. J. Phys.*, **46**, 1619 (1968).

(25) J. E. Collin and P. Natalis, *Chem. Phys. Letters*, **2**, 194 (1968).

(26) D. W. Turner and C. R. Brundle, unpublished work.

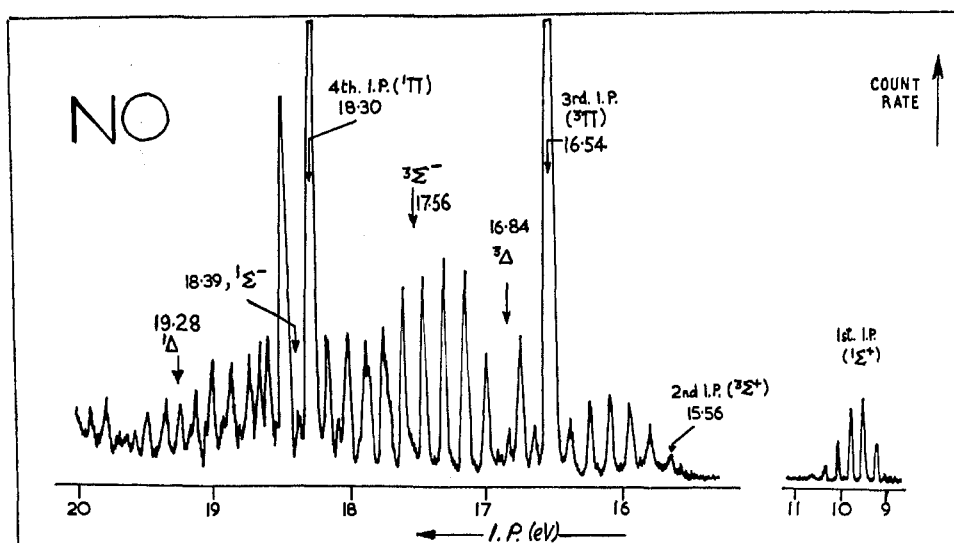

Figure 7. The He 584-Å PE spectrum of NO, showing the different ionic states (after Turner,²⁶ 1968).

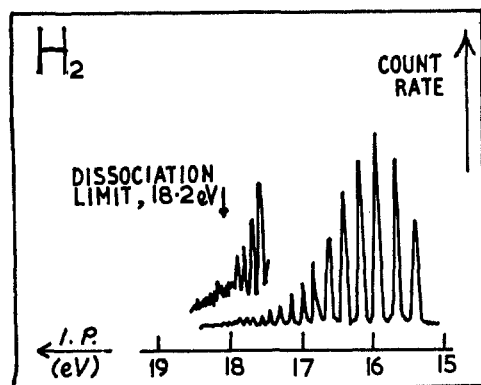

Figure 8. The He 584-Å PE spectrum of H₂, showing the formation of H₂⁺ ions in vibrational levels up to the dissociation limit (after Turner, see text).

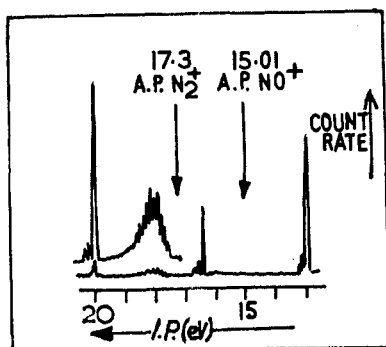

Figure 9. The He 584-Å spectrum of N₂O (after Brundle and Turner²⁸) with the appearance potentials of NO⁺ and N₂⁺ ions marked on it (see text).

7). The spectra of all diatomic molecules examined to date using high-resolution electrostatic 127° sector analyzers reveal well-resolved vibrational structure in all the bands, permitting the accurate measurement of ionic vibrational frequencies and relative transition probabilities ("Franck-Condon factors"). The spectrum of H₂, for example, shows (Figure 8) the results of ionization from the only occupied orbital (1s σ_g) of

the molecular ground state. A series of peaks can be seen stretching across the entire band and slowly converging to the dissociation limit of H₂⁺ at 18.1 eV.¹² In general, however, it is found that vibrational levels near ionic dissociation limits are *not* populated to any observable extent by direct photoionization. Thus Figure 9 shows the PE spectrum of N₂O, with the appearance potentials of the NO⁺ and N₂⁺ fragment ions (measured from photoionization efficiency curves²⁷) marked on it. Since the PE spectrum reveals all the vibrational levels of the molecular ions populated by direct ionization, it is evident that direct photoionization cannot produce N₂O fragment ions by direct transitions to any of the ionic states observed, since population at the dissociation limits does not occur. Similar results are reported by Brundle and Turner²⁸ for CO₂, COS, and CS₂, and this must mean that in many cases fragmentation takes place by curve crossing out of directly populated ionic states or out of excited molecular states. Brundle and Turner's suggested mechanism for the production of NO⁺ ions from N₂O involves the initial production of a dissociative state of the neutral molecule which then autoionizes to the continuum of the ionic ground state (²Π_g) as indicated schematically in Figure 10.

In cases where Franck-Condon (FC) factors for molecules have been calculated,²⁹⁻³¹ good agreement is often found with experimental FC factors measured from 584-Å PE spectra.^{14,28,32} However, considerable

(27) V. H. Dibeler and J. A. Walker, paper presented at the International Conference on Mass Spectrometry, Berlin, 1967; V. H. Dibeler, *J. Chem. Phys.*, **47**, 2191 (1967). See also V. H. Dibeler and J. A. Walker, *J. Opt. Soc. Amer.*, **57**, 1007 (1967).

(28) C. R. Brundle and D. W. Turner, *Intern. J. Mass Spectry, Ion Phys.*, **2**, 195 (1969).

(29) R. Botter and H. M. Rosenstock, paper presented at the International Conference on Mass Spectrometry, Berlin, 1967.

(30) M. Hallmann and I. Laulicht, *J. Chem. Phys.*, **43**, 1503 (1965).

(31) T. E. Sharp and H. M. Rosenstock, *ibid.*, **41**, 3453 (1964); M. E. Wacks, *ibid.*, **41**, 930 (1964).

(32) C. R. Brundle and D. W. Turner, *Proc. Roy. Soc. (London)*, **A307**, 27 (1968).

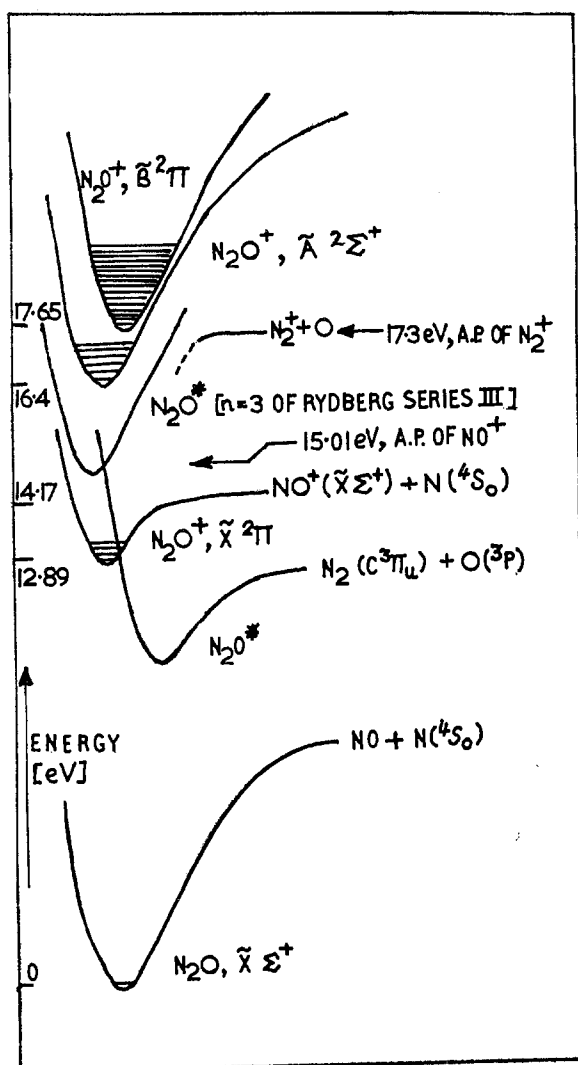

Figure 10. Possible pathway to the production of NO^+ ions from N_2O at 15.01 eV (after Brundle and Turner²⁶). The diagram also shows all the ionic vibrational levels populated by irradiation of N_2O with 584-Å photons.

apparent variations in experimental FC factors have occasionally been observed on varying the light source photon energy. For example, the first band in the spectrum of O_2 shows considerably different structure depending upon the light source used.²¹ Many more levels of the ${}^2\Pi_u$ O_2^+ ion are populated when neon resonance rather than He resonance radiation causes ionization. This phenomenon would seem to depend upon the proximity of the energy of one of the irradiating resonance lines (in this case neon) to the energy of an excited neutral state of the O_2 molecule which can autoionize to the ${}^2\Pi_u$ ionic state.

Autoionization processes are not normally detectable by PES because they require coincidence of the energy of an autoionizing state with the energy of the incident photons. Furthermore, even if the energy needed to populate the autoionizing level should coincide with the photon frequency, the electrons eventually released on autoionization can only have the same energy as if they had resulted from a direct ionization process. However, it does seem that when such a coincidence

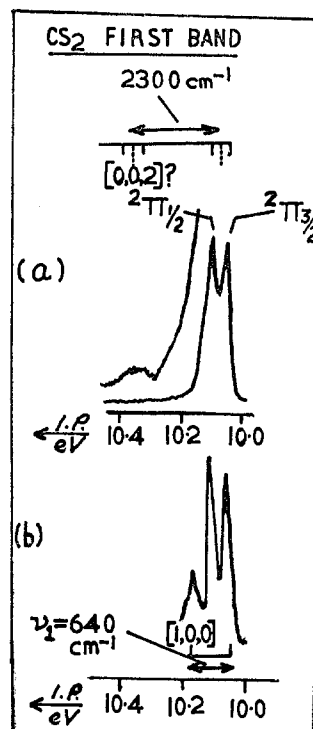

Figure 11. First band in the PE spectrum of CS_2 as obtained with (a) He 584-Å and (b) Ar 1048-Å light sources. Note the excitation of (1,0,0) in b but not in a.

exists, the over-all FC factors for the process $X \rightarrow X^* \rightarrow X^+ + e^-$ are often so different from those for the direct process $X \rightarrow X^+ + e^-$ that the effect is seen in the PE spectrum.

A further example of this is that the first band in the PE spectrum of CS_2 ³³ shows variations in band shape depending upon whether argon resonance or He 584-Å radiation is used to excite the spectrum (Figure 11). Here, a vibrational mode excited in the $\text{CS}_2^+ {}^2\Pi_{1/2}$ ion by the Ar 1048-Å (11.82 eV) line is not excited by irradiation with either the lower energy Ar resonance line (1067-Å) or the He 584-Å line. This is consistent with photoionization efficiency measurements²⁷ showing a CS_2 autoionizing state at about 11.8 eV above the molecular ground state. Berkowitz and Chupka explain the effects of autoionization on PE spectra in terms of the FC factors connecting the quasi-discrete state and the ionic state(s) to which it autoionizes.³⁴

In addition to CS_2 , many triatomic molecules have been examined by 584-Å PES.^{28,32,35-37} Collin and Natalis³⁸ have also used a coaxial grid analyzer to study the PE spectra of triatomic molecules irradiated with lower energy light sources and have reported the appearance of completely new bands (*i.e.*, ones un-

(33) C. R. Brundle and D. W. Turner, private communication.

(34) J. Berkowitz and W. A. Chupka, to be published.

(35) D. W. Turner and D. P. May, *J. Chem. Phys.*, **46**, 1156 (1967).

(36) P. Natalis and J. E. Collin, *Chem. Phys. Letters*, **2**, 79 (1968).

(37) J. H. D. Eland and C. J. Danby, *Intern. J. Mass Spectry. Ion Phys.*, **1**, 111 (1968).

(38) J. E. Collin and P. Natalis, *ibid.*, **1**, 121 (1968).

detected at 584 Å) under these conditions. However, work with sector analyzers³³ at the lower photon energies has failed to reproduce these bands, and thus their origin is in some doubt.

The highest resolution studies on triatomic molecules have been carried out by Brundle and Turner.^{28,32} The spectra obtained for CO₂, CS₂, COS, and N₂O are correlated with the MO calculations of previous workers and, as mentioned previously, with the photoionization efficiency curves reported by Dibeler and Walker.²⁷ Brundle and Turner point out that the spectra leave no question that the valence shell orbital ionization potentials of CO₂ decrease in the order $(\sigma_g)^2$, $(\sigma_u)^2$, $(\sigma_g)^2$, $(\sigma_u)^2$, $(\pi_u)^4$, $(\pi_g)^4$. This is in conflict with the previous interpretations of Collin and Natalis,³³ who supposed the second ionization potential to characterize a $(\sigma_u)^2$ electron and the third a $(\pi_u)^4$ electron, in accord with theoretically calculated orbital orderings.³⁹⁻⁴² That the ordering proposed by Brundle and Turner is correct is indicated by the emission spectrum of CO₂⁺ obtained by Mrozowski,⁴³ who identified the ${}^2\Pi_u \rightarrow {}^2\Pi_g$ transition as having an energy of 3.535 eV. This is precisely the energy gap between the first and second ionization potentials of CO₂. The orbital ionization potential orderings for CS₂ and COS are deduced by Brundle and Turner to parallel that of CO₂, but the experimental order of the ionization potentials of N₂O found by PES is, in decreasing order, $(\sigma)^2$, $(\sigma)^2$, $(\pi)^4$, $(\sigma)^2$, $(\pi)^4$, and thus differs from the other linear triatomic molecules in that the lower π level ionization potential is greater than the highest occupied σ level ionization potential. However the general bonding characteristics would appear to be similar to the corresponding orbitals of CO₂, CS₂, and COS.

A number of polyatomic inorganic and organometallic compounds including C₃O₂,⁴⁴ NH₃,⁴⁵ phosphorus, silicon, and germanium hydrides,⁴⁶ sulfur hexafluoride,⁴⁵ boron halides,⁴⁷ metallocenes,⁴⁵ metal carbonyls,⁴⁵ and isocyanic acid⁴⁸ have been studied by PES. In every case the results have been reconciled with the electronic structures of the molecules concerned.

A whole range of organic molecules have also been examined. Low-resolution spectra of alkanes were reported by Al-Joboury and Turner⁴⁹ in 1964, and meth-

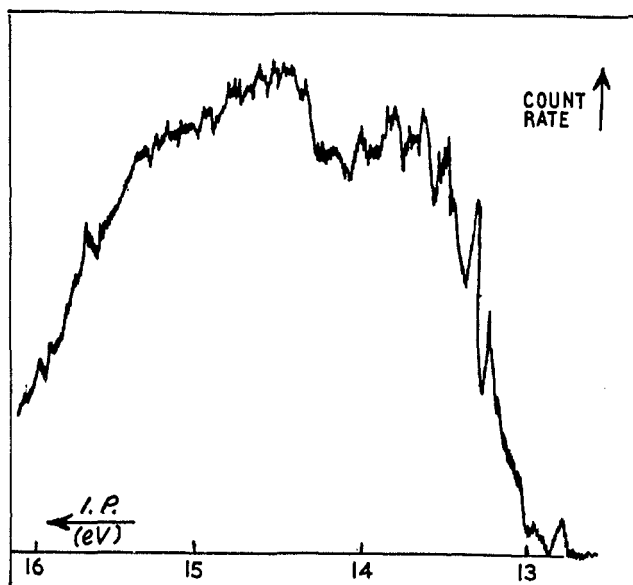

Figure 12. The He 584-Å PE spectrum of methane, showing the band corresponding to ionization from the $(\pi_2)^4$ level (see text).

ane and ethane were reexamined under much higher resolution conditions by Turner and coworkers in 1968.⁵⁰ An interesting feature of the high-resolution PE spectra of methane and ethane is that evidence for Jahn-Teller distortions in some of the molecular ions is apparent. Thus the He 584-Å spectrum of methane (Figure 12) exhibits a double maximum in the band corresponding to ionization from the π_2 orbital. A triply degenerate tetrahedral CH₄⁺ ion cannot be stable according to the Jahn-Teller theorem, and consequently the PE spectrum can be rationalized in terms of transitions to CH₄⁺ ionic states with symmetries lower than T_d, *i.e.* C_{3v} and C_{2v}. The amount of splitting observed is *ca.* 0.7 eV, and similar splittings have been found in other cases where Jahn-Teller distortion would be expected to occur.^{45,46,51} Such splittings can thus help to characterize bands arising owing to the ejection of electrons from degenerate orbitals in nonlinear molecules.

Organic molecules containing π electrons give interesting photoelectron spectra. Ionization from the π orbitals is often found to be characterized by PE bands showing well-resolved fine structure, as can be seen from the bands representing the highest occupied (π) orbitals in ethylene,⁵⁰ acetylene,⁵² and benzene^{53,54} (see Figure 13), and also in more complex systems.⁵⁵

(39) A. D. McLean, *J. Chem. Phys.*, **32**, 1595 (1960).

(40) J. F. Mulligan, *ibid.*, **19**, 347 (1951).

(41) S. D. Peyerimhoff, R. J. Buenker, and J. L. Whitten, *ibid.*, **46**, 1707 (1967).

(42) E. Clementi, *ibid.*, **36**, 750 (1962).

(43) S. Mrozowski, *Phys. Rev.*, **72**, 691 (1947).

(44) C. Baker and D. W. Turner, *Chem. Commun.*, 400 (1968).

(45) D. W. Turner, A. D. Baker, C. Baker, and C. R. Brundle, "High Resolution Molecular Photoelectron Spectroscopy," John Wiley & Sons, Ltd., in press.

(46) W. C. Price, paper presented at the Royal Society Symposium on Photoelectron Spectroscopy, London, 1969; *Proc. Roy. Soc. (London)*, in press.

(47) R. J. Boyd and D. C. Frost, *Chem. Phys. Letters*, **1**, 649 (1968).

(48) J. H. D. Eland, paper presented at the Royal Society Symposium on Photoelectron Spectroscopy, London, 1969; to be published (*cf. ref. 46*).

(49) M. I. Al-Joboury and D. W. Turner, *J. Chem. Soc.*, 373 (1967).

(50) A. D. Baker, C. Baker, C. R. Brundle, and D. W. Turner, *Intern. J. Mass Spectry. Ion Phys.*, **1**, 285 (1968).

(51) C. Baker and D. W. Turner, *Chem. Commun.*, 480 (1969).

(52) C. Baker and D. W. Turner, *Proc. Roy. Soc. (London)*, **A308**, 19 (1968).

(53) A. D. Baker, D. P. May, and D. W. Turner, *J. Chem. Soc., B*, 22 (1968).

(54) A. D. Baker, C. R. Brundle, and D. W. Turner, *Intern. J. Mass Spectry. Ion Phys.*, **1**, 443 (1968).

(55) J. H. D. Eland and C. J. Danby, *Z. Naturforsch.*, **23a**, 355 (1968).

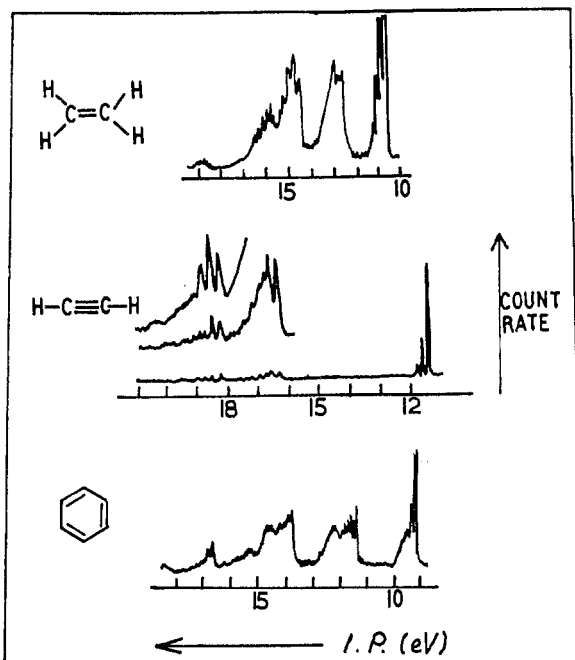

Figure 13. The He 584-Å PE spectra of (a) ethylene, (b) acetylene, and (c) benzene.

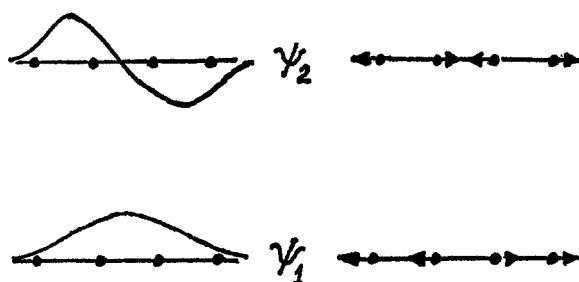

Figure 14. Vibrations identified as being excited by ionization from upper and lower π levels of diacetylene, cyanoacetylene, and cyanogen (see ref 51).

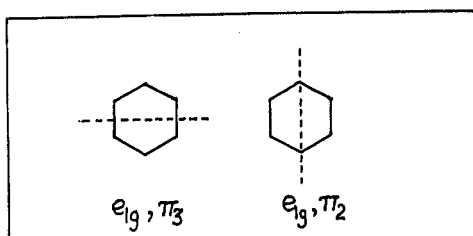

Figure 15. Nodal planes (---) in the degenerate $(e_{1g})^4$ orbitals of benzene.

Linear molecules containing conjugated systems of multiple bonds have been studied by Baker and Turner.⁵² Vibrational structure on many of the bands was interpreted, and frequently the modes of vibration identified as being excited in the ions were used to clarify the bonding types of the orbitals from which ionization occurred. Thus in the spectra of diacetylene, cyanoacetylene, and cyanogen, the bands associated with the upper and lower π levels show the excitation of the vibrational modes which would be predicted on

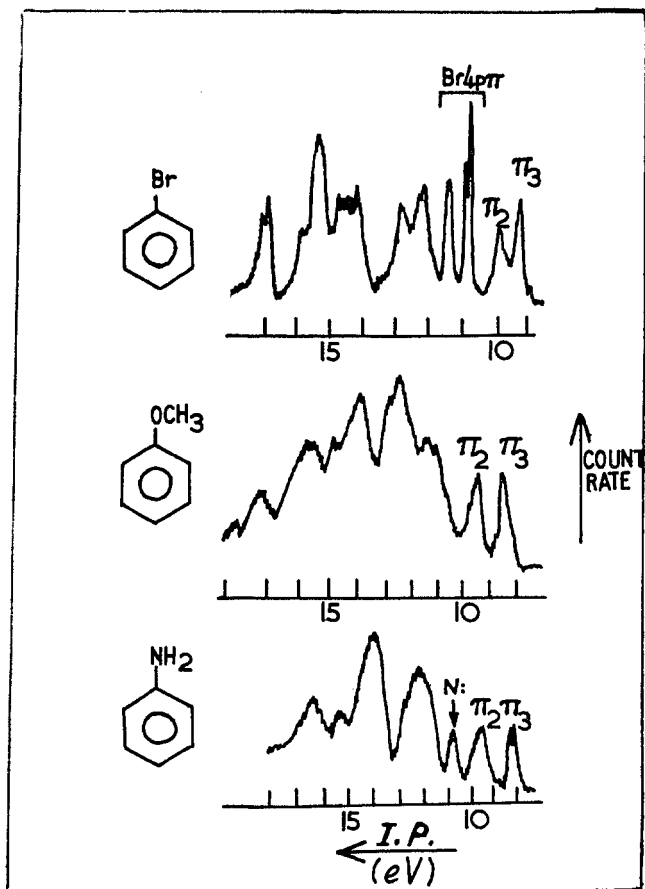

Figure 16. Sketches of the PE spectra of benzene derivatives, illustrating the lifting of the degeneracy of the $(e_{1g})^4$ π levels by mesomeric substituents.

account of the nodal properties of the orbitals (Figure 14).

The potentiality of PES in assessing substituent effects is revealed by the spectra of benzene derivatives.⁵³ The highest occupied orbital of the benzene molecular ground state is $(e_{1g})^4$, consisting of degenerate π_3 and π_2 components with the nodal properties shown in Figure 15. Substitution of the benzene ring would in certain instances be expected to lift the degeneracy of the π_3 and π_2 orbitals since one of the orbitals has a node at the point of substitution while the other has its maximum electron density. This lifting of degeneracy is demonstrated clearly in the PE spectra of many benzene derivatives (Figure 16) where the first band is seen to be split into two components. The energy separation of the two components is found to reflect the mesomeric effect of the substituent—*e.g.*, CF_3 , purely inductive, gives no splitting—whereas the over-all shifts of the bands from the position of the first band in the spectrum of benzene itself is a measure of the inductive effect.^{45,53}

Compounds containing atoms with ionizable lone pairs of electrons give rise to characteristic sharp PE spectral peaks. Furthermore, the ionization potential values corresponding to these peaks are sensitive to molecular environment (see Figure 17) so that the possibility of using PES as an analytical tool suggests

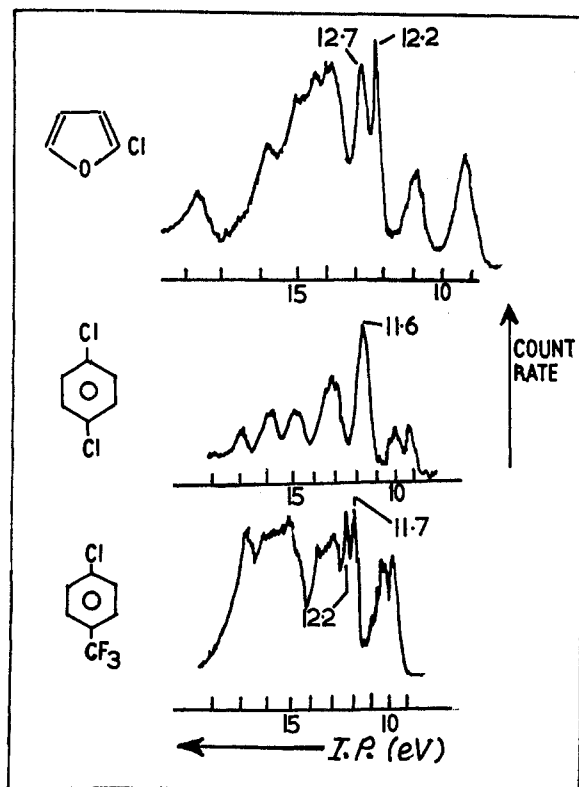

Figure 17. Low-resolution PE spectra showing the dependence of chlorine "lone-pair" ionization potentials on chemical environment.

itself.^{45,53,56} The appearance (Figure 17) of two "lone-pair" peaks in the spectra of compounds such as chlorobenzene may seem a little surprising at first, but can be explained in terms of the two Cl lone-pair orbitals interacting to different extents with the aromatic ring π electrons. One of the halogen "lone-pair" orbitals is coplanar with the aromatic ring, while the other is perpendicular to it, and consequently the latter would be expected to retain more of its nonbonding character. Similar effects have been found in vinyl halides,^{45,47} halopyridines,⁵⁷ and halothiophenes.⁵⁸

(56) D. Betteridge and A. D. Baker, paper presented at the International Symposium on Analytical Chemistry, Birmingham, 1969; submitted for publication.

Nitrogen "lone-pair" electrons in compounds such as anilines and azines have been found by PES to be more bonding than halogen lone pairs, an observation in keeping with MO calculations indicating considerable delocalization of the "lone pair" through the σ bonds of the molecules concerned.^{45,47}

Areas of current interest in PES include studies on the angular distribution of photoelectrons, both from a theoretical and practical point of view,⁵⁹⁻⁶³ the possibility of using coincidence techniques to study the photoions produced concurrently with electrons of specific kinetic energies,⁶⁴ the ultimate factors determining resolving power,⁶⁵ the measurement of threshold photoelectrons,⁶⁶ and the problems involved in correlating experimentally measured ionization potentials with theoretically calculated orbital energies^{45,67,67-72} Lack of space precludes any detailed discussion, and the interested reader is referred to the original papers.

I wish to thank Drs. D. W. Turner, D. Betteridge, C. R. Brundle, and C. Baker for their kind help in the preparation of the script. I am also grateful to Dr. J. Berkowitz for many helpful comments and criticisms.

(57) A. D. Baker and D. W. Turner, paper presented at the Royal Society Symposium on Photoelectron Spectroscopy, London, 1969; submitted for publication (cf. ref 46).

(58) A. D. Baker, D. Betteridge, and N. R. Kemp, unpublished results.

(59) J. Cooper and R. N. Zare, *J. Chem. Phys.*, **48**, 942 (1968).

(60) M. Siechel; see notes to ref 46, 48, and 56.

(61) J. Berkowitz and H. Ehrhardt, *Phys. Letters*, **21**, 531 (1966).

(62) J. Berkowitz, H. Ehrhardt, and T. Tekaas, *Z. Phys.*, **200**, 69 (1967).

(63) J. A. R. Samson, *J. Opt. Soc. Amer.*, **59**, 356 (1969).

(64) B. Brehm and E. von Puttkamer; see note to ref 27.

(65) D. W. Turner, *Nature*, **213**, 795 (1967).

(66) D. Villarejo, R. Stockbauer, and M. G. Inghram, *J. Chem. Phys.*, **48**, 3342 (1968); D. Villarejo, *ibid.*, **48**, 4014 (1968); **50**, 4599 (1969).

(67) W. G. Richards and R. C. Wilson, *Trans. Faraday Soc.*, **64**, 1729 (1968).

(68) M. J. S. Dewar and S. D. Worley, *J. Chem. Phys.*, **50**, 654 (1969).

(69) B. Jonsson and E. Lindholm, *Chem. Phys. Letters*, **1**, 501 (1967).

(70) G. L. Caldow and G. F. S. Harrison, *Tetrahedron*, **25**, 3429 (1969).

(71) H. Basch, M. B. Robin, N. A. Kuebler, C. Baker, and D. W. Turner, *J. Chem. Phys.*, **51**, 52 (1969).

(72) H. Basch, M. B. Robin, N. A. Kuebler, C. R. Brundle, and D. W. Turner, *ibid.*, **49**, 5007 (1968).